

Technical Data Sheet

Date: 03/11/2022

3x16A CEE N. Angled Panel Mount Socket

Ref. No: 3120-309-0900



Pack Unit

10



Weight

124 gr.



Technical Informations



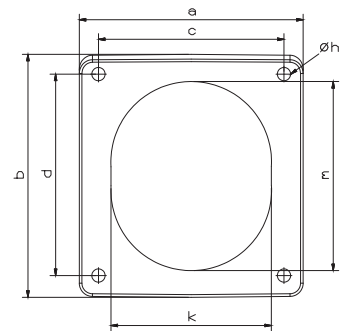
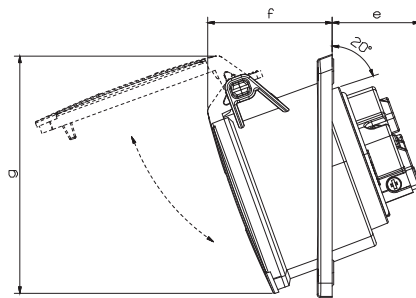

Ampere	16A
Voltage	200 - 250 V. AC
Hertz	50 - 60 Hz
Protection Class	IP 44
Clock Position	6h
Number Of Poles	3 (2P + E)
Contact Material	Brass (CuZn)
Housing Material	PA6
Connection Type	Screw
Operation Temp. (-25 / + 40 IEC 60309)	-25 / +80 (1 hour -100° C)

Dimensions

a	83	e	33
b	90	f	43
c	70	g	90
d	76	Øh	5
Cable Diameter (Min.)	1 mm ²	k	52
Cable Diameter (Max.)	4 mm ²	m	65

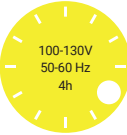

Different Earth Contact Positions (Clock Positions)

 >50V 300-500 Hz 2h 3120-309-1100-2h	 100-130V 50-60 Hz 4h 3120-309-0700-4h	 200-250V 50-60 Hz 6h 3120-309-0900	 480-500V 50-60 Hz 7h 3120-309-0300-7h	 380-415V 50-60 Hz 9h 3120-309-1600-9h
---	---	--	---	---



Tel: +90 232 880 90 01
Fax: +90 232 880 90 02



info@tpelectric.com.tr



Kemalpaşa O.S.B. 600 Sk. No:364
35730 Kemalpaşa - İZMİR / TÜRKİYE