

Technical Data Sheet

Date: 22/08/2022

72x72x57 Aluminium Enclosure

Ref. No: 3390-809-0600



Pack Unit

20



Weight

259 gr.



Technical Informations

Protection Class	IP 67
Housing Material	Aluminum Injection
Screw Material	Stainless Steel INOX
Liquid Foaming	<input checked="" type="checkbox"/>
Earth Contact On Base	<input checked="" type="checkbox"/>

Dimensions

Kapak / Cover

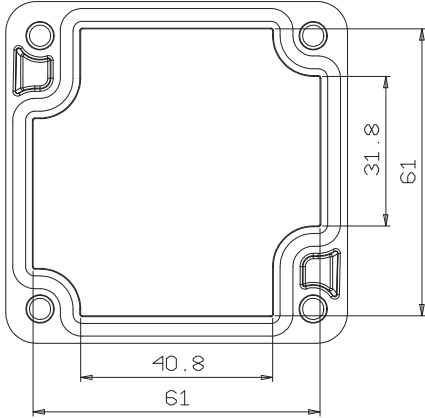

Gövde / Housing

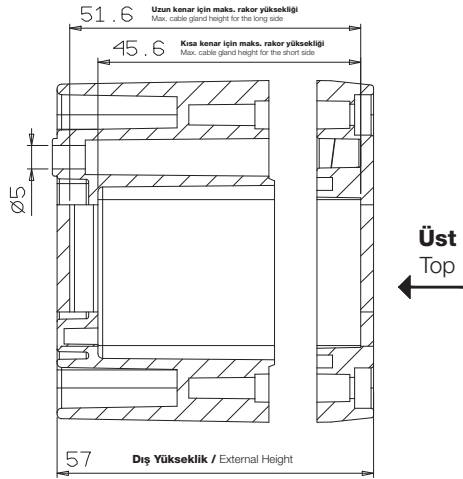
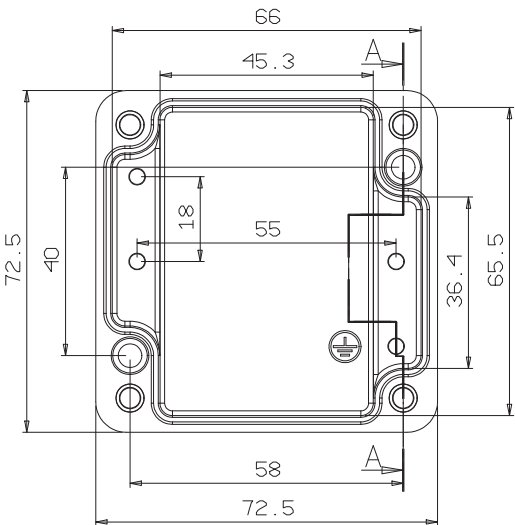

Tel: +90 232 880 90 01
Fax: +90 232 880 90 02



info@tpelectric.com.tr



Kemalpaşa O.S.B. 600 Sk. No:364
35730 Kemalpaşa - İZMİR / TÜRKİYE